



INSTRUCTION MANUAL



STEAM IRON
Model Name: Mistello
Model No.: MI1300NS





Dear Customer,

Congratulations!

You are now the proud owner of USHA Household Steam Iron.

Innovatively designed, using only the highest quality material and components, your USHA Household Steam Iron is designed for years of trouble free performance.

Please read this Instruction Manual carefully before using and keep it cautiously after reading for future reference.

BestWishes

IMPORTANT PRECAUTIONS

When using your steam iron, following safety precautions should always be followed:

- Read all instructions
- Use iron only for its intended Domestic/Household use only
- To protect against risk of electric shock, do not immerse the iron in water or any other liquid
- Do not touch the hot metal part, hot water, or steam to avoid scalding
- The iron should always be turned off before unplugging from outlet. Never yank cord to disconnect from outlet; instead grasp plug and pull to disconnect.
- Use Distilled water or De-Mineralised water in the iron tank. Do not fill in with any other liquid except water.
- Do not allow cord to touch hot surfaces. Let iron cool completely before putting away.
- Loop cord loosely around Iron when storing.
- Always disconnect iron from electrical outlet when filling with water or emptying and when not in use.
- Do not operate iron with a damaged cord or if the iron has been dropped or damaged. To avoid the risk of electric shock, do not disassemble the iron. Contact USHA Care.
- Close supervision is necessary for any appliance being used near children.
- Do not leave iron unattended while connected or on an ironing board.
- Burns can occur from touching hot metal parts, hot water or steam. Be cautious when you turn a steam iron upside down, there may be water in the reservoir
- The appliance is designed for domestic use and may only be operated in accordance with these instructions for use.
- The appliance generates high temperature steam. Always handle with care.

DO's

1. Check the mains voltage stated on the rating plate corresponds to the local electricity supply.
2. Unwind and straighten the power cord and supply cord before use.
3. Place the appliance on a firm and steady surface.
4. The iron must be used and rested on a stable surface
5. Avoid power cord or supply cord touching the sole plate.
6. The plug of the supply cord must be removed from the socket-outlet before the water reservoir is filled with water
7. Keep electrical appliances out of reach from children or infirm persons. Do not let them use the appliances without supervision.
8. When placing the Iron on its stand, ensure that the surface on which the stand is placed is stable.
9. If the power cord or supply cord is damaged, it must be replaced by the authorized company service centre or its service agent.

10. Empty the water tank after use.
11. This appliance is not intended for use by persons (including children) with reduced physical, sensory or mental capabilities, or lack of experience and knowledge, unless they have been given supervision or instruction concerning use of the appliance by a person responsible for their safety

DO NOT's

1. Do not allow children to touch the appliance when ironing.
2. Do not leave the appliance unattended when it is connected to a main supply outlet.
3. Do not use an extension power cord set unless competent authority has approved it.
4. Do not add perfumed, vinegar or other chemical liquids into the water tank; they can damage the appliance.
5. Do not immerse the appliance in water or any other liquid.
6. Do not use the appliance when it is damaged or performs abnormally.
7. The iron is not to be used if it has been dropped, if there are visible signs of damage or its leaking.
8. Do not touch the iron rest during or just after ironing. It is hot!
9. Do not roll the power cord or supply cord around the iron unit or base console for storage until it has cooled down completely.
10. Do not attempt to open the cabinet or dismantle any parts from the appliance, there is no serviceable part inside.

Please read these instructions for use and have a good look at the illustration before using the appliance

PART LIST

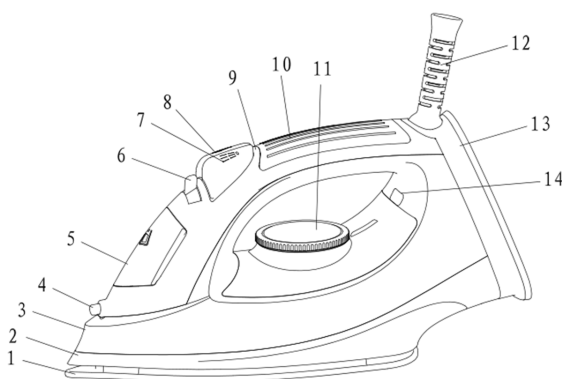

1. Soleplate
2. Plastic Skirt
3. Water Tank
4. Spray Head
5. Water Tank Cover
6. Steam Dial
7. Spray Button
8. Burst Button
9. Handle
10. Anti-slide Cover
11. Thermostat Knob
12. Cord Protector
13. Back Cover
14. Power Lamp

TECHNICAL SPECIFICATIONS

| | |
|---------------------|--------------------------------|
| Power Supply | 240 V, 50 Hz, Single Phase, AC |
| Wattage | 1300 Watts |
| Water Tank Capacity | 250 ml |
| Sole Plate | Non-stick PTFE Coating |

Due to continuous efforts for product up gradation, specifications are subject to change without prior notice.

CAUTIONS:

1. Make sure that the applied voltage is same as the rating voltage, and the socked has effective earth connection.
2. If the supply cord is damaged, it must be replaced by the manufacturer, its service agent or qualified persons in order to avoid a hazard.
3. This iron is for household only.
4. Do not immerse the iron into any liquid for cleaning.
5. Do not touch the hot metal part, hot water, or steam to avoid scalding.

FEATURES

1. Wattage: 1300 Watts-powerful performance for effortless removal of wrinkles.
2. Non stick PTFE coated sole plate for smooth gliding on clothes.
3. Water tank capacity of 250 ml
4. Dry/Steam/Spray ironing function-effectively moistens clothes for a crisp ironing finish.
5. Steam output of up to 18gm/min at maximum temperature setting for removing tough wrinkles effortlessly.
6. 360 degree swivel cord for easy maneuverability.
7. Easy Grip Handle for ironing comfort.
8. Overheat Safety Shut Off.
9. Thermostat dial for controlling fabric Temperature.
10. Indicator Lamp for Power ON/OFF.
11. ISI Mark-Safety of Use.
12. Warranty - 2 years.

SPECIAL INSTRUCTIONS

To avoid circuit overload, do not operate another high wattage appliance on the same circuit.

If an extension cord is absolutely necessary a 10 ampere cord should be used. Cords rated for less amperage may overheat. Care should be taken to arrange the cord so that it cannot be pulled or tripped over.

INSTRUCTIONS BEFORE FIRST USE

1. Some parts of iron have been slightly greased and as a result the iron might slightly smoke when switched on for the first time. After a short while, this will cease.
2. Before using the iron first remove any sticker or protective foil from the sole plate with a soft cloth.
3. Keep the sole plate smooth; do not scratch against metal object (e.g. rack of ironing board, buttons, zippers.)
4. Pure woollen fabrics (100% wool) may be pressed with the iron set to a steam position. Preferably select steam selector position and use a dry pressing cloth.
5. When using the iron for the first time, test an old piece of fabric to ensure that the sole plate & water tank are completely clean.

HOW TO USE IRON

Setting the Temperature







1. Always check first whether ironing instructions are attached to the article to be ironed. (They can be found on a label showing a drawing of an iron. The number of dots indicate the correct temperature. Refer to the indications on the temperature dial.) Follow these ironing instructions in all cases.
2. If ironing instructions are missing but you do know the kind of fabric, then see the temperature dial as below. This is valid for the actual material and do not concern any applied finish.
3. Textile to which some kind of finish has been applied (gloss, wrinkle, relief etc.) can best be ironed at somewhat lower temperature.
4. If the fabric consists of various kinds of fibres, you must always select the lowest ironing temperature of the composition. (E.g. an article consisting of 60% polyester and 40% cotton, it should be ironed at the temperature indicated for polyester (*) and without steam.)
5. Sort the fabrics according to ironing temperature first; wool with wool, cotton with cotton etc. The iron heats up quicker than it cools down. Therefore, start ironing the articles requiring the lowest temperature such as those made of synthetic fibres. Then progress to the higher ones.
6. Turn the temperature control knob round until it is opposite the setting pointer.
7. The correct temperature will be reached when the pilot light has turned off. The pilot light will be ON and OFF from time to time indicating that the selected temperature is being maintained.

TIPS FOR IRONING

1. Sort out the articles to be ironed according to the type of fabric. This will minimize the frequency of temperature adjustment for different garments.
2. Test ironing a small area on the backside or inside the garment if you are unsure about the type of fabric. Start with a low temperature and increase gradually.
3. Wait for about three minutes before ironing heat sensitive fabrics. Temperature adjustment needs certain time to reach the required level no matter it is higher or lower.
4. Delicate fabrics such as silk, wool, etc. are best ironed with an ironing cloth to prevent shine marks.
5. You may need to press the spray button a few times to activate the spray function.

READ THE GARMENT LABELS AND FOLLOW THE MANUFACTURER'S IRONING INSTRUCTIONS THAT ARE OFTEN SHOWN BY SYMBOLS SIMILAR TO THE FOLLOWING:

TEMPERATURE TABLE:

| Temperature Control Setting | | |
|--|--|--|
|  <ul style="list-style-type: none">• Acetate• Elastano• Polyamide• Polypropylene  |  <ul style="list-style-type: none">• Polyester• Silk• Triacetate• Viscose• Wool  |  <ul style="list-style-type: none">• Cotton• Linen  |

FIRST TIME STEAM IRONING

1. Remove any protective films or stickers from the sole plate and the cabinet.
2. Unwind and straighten the power cord.
3. Fill the water tank. (See How To Fill Water)
4. Connect the iron to a suitable mains supply outlet.
5. Turn the Temperature Dial in clockwise direction to maximum position; pilot light glows.
6. Pilot light goes off when the required temperature is reached.
7. Move the Variable Steam Control Knob to position; steam starts coming out from the holes in the sole plate.
8. Begin first time ironing with an old towel.
9. When the water tank is empty and there is no more steam produced; the preparation work is completed. The iron is now ready for proper use.

DRY IRONING

1. Select the setting on the temperature Dial most suitable for the fabric to be ironed.
2. Once the Heating indicator Light has gone out, commence ironing.

Ensure that there is sufficient water in the water tank if you wish to use the spray facility while dry ironing. If dry ironing is to be done for more than 20 minutes, then water tank should be emptied to prevent over heating of any water present.

HOW TO FILL THE WATER

1. Set the "variable steam knob" to the lowest position before filling the iron with water.
2. Remove plug from the socket.
3. Open the water filling inlet cover, with the iron held on an angle as shown. Use the water measure fill beaker to pour water into the filling mouth
 - If the water is very hard, it is advised to use distilled water or de-mineralised water only.
 - Do not use chemically de-scaled water.
 - The harder the water, the more the iron should be self cleaned.
4. Push firmly to close the cover.
5. Never try to fill water above "Max" mark to avoid overfilling.
6. Pour out the remaining water after use.

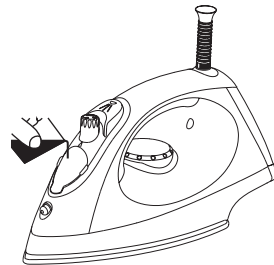

A SPECIAL NOTE ON WATER;

Water containing sediments and alkalis will cause blocking of steam holes. You can use tap water in your iron, unless it is particularly hard, in which case the use of distilled or de-mineralised water is advised.

***Note:** The Images displayed along with the functionalities are for illustrative purposes only and may not match the actual product

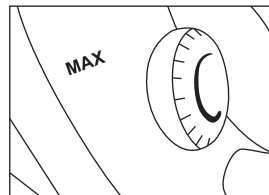

STEAM IRONING

- 1 This function can be used only at higher ironing temperature.
- 2 •• for moderate steam.
- 3 ••• or MAX for maximum steam. Fill water into the iron as described above.
- 4 Stand the iron on its rear side.
- 5 Connection the iron to a suitable mains supply outlet.
- 6 Turn the temperature control to the required fabric setting.
- 7 The pilot light turns off when the temperature is reached.

The iron is ready for use. Turn the steam knob to the required position, steam starts coming out from the holes in the sole plate.

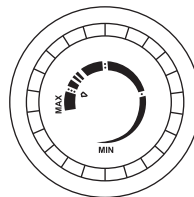

BURST OF STEAM

- 1 This function provides an extra amount of steam to remove stubborn wrinkles.
2. Fill the iron with water as described above.
3. Turn the temperature control to the position "MAX".
4. The pilot light turns off when the required temperature is reached.
5. The iron is ready for use.
6. Press the burst button as per indication.
7. Steam will penetrate into the garment removing the wrinkles.
8. Usually all wrinkles can be removed within three pressing.
9. Wait at least 3 sec. between each press of steam burst button.

SPRAY

1. Spray may be used on any setting, steam or dry.
2. Press the knob for spray function.

NOTE: Repeat pumping is required to start this function.

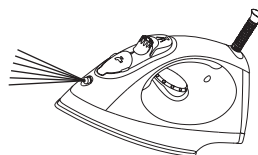

CLEANING & MAINTENANCE

1. Disconnect the iron from the mains supply outlet.
2. Use a damp cloth or non-scratching cleaner to remove any deposits on the sole plate or the cabinets.

NOTE:

1. Never use sharp or rough objects to remove the deposits on the sole plate. Never use any abrasive vinegar or de-scaling agents to clean the iron.
2. The Images displayed along with the functionalities are for illustrative purposes only and may not match the actual product

DRAINING THE WATER

1. Disconnect the iron from the mains supply outlet.
2. Hold the iron upside down and gently shake it to remove any remaining water out of the filling hole.
3. When the iron gets cool completely, store it vertically in a safe place.

CLEANING THE IRONING SURFACE

To remove or clean starch or other materials from the ironing surface, apply a small amount of mild cleaner to a damp cloth forming a paste on the cloth. Gently rub ironing surface of iron, then wipe with moist cloth. Never use metallic pads.

CAUTION:

Never use scouring pads, abrasive or harsh cleaners as this may scratch the surface.

WHILE TRAVELLING OR WHEN MOVING HOUSEHOLD GOODS

When iron has cooled down sufficiently, pack it carefully. The original carton is not a suitable mailing carton. The iron should be protected by additional packaging. Be careful to pack iron so that plug does not come in contact with sole plate.

In case of any defect, do not tamper with the appliance yourself. Contact USHA Care.

STORAGE:

After using, pull out the plug, pour out the remaining water, turn the steam control to minimum, turn the temperature control to "min", let the iron cool down, put the iron on the safe and dry place vertically.

WARRANTY CARD

This appliance is warranted for 2 years against all manufacturing defects from the date of sale. In the event of any complaint, please contact Usha Care at Toll Free No. 1800 1033111.

THE WARRANTY IS VALID ONLY WHEN:

1. The appliance has been used and maintained in accordance with the instruction manual.
2. The appliance has not been opened or tampered with, by any unauthorized person.
3. The warranty card or cash memo duly signed by the authorized dealer are presented with the complaint.

THIS WARRANTY DOES NOT APPLY FOR...

1. Damages due to chipping, peeling, plating and denting.
2. Breakage or damage to components made out of Bakelite, Urea, ABS, SAN and such plastic, materials, rubber parts and cord.
3. Normal wear and tear of parts.
4. Damage resulting from accidents, mishandling or negligence on part of the customer.

Liability for consequential loss or damage is neither accepted nor implied.

S.NO: _____

CASH MEMO: _____ DATE: _____

DEALER'S NAME AND ADDRESS: _____

OWNER'S NAME & ADDRESS: _____

USHA care[®]

Toll free
1800-1033-111

Email: corporate@usha.com

 <http://www.facebook.com/ushainternational>

USHA INTERNATIONAL LTD.

Plot No. 15, Institutional Area, Sector 32, Gurugram-122 001, Haryana (India) Tel : +91-124-4583100, Fax : +91-124-4583200

E-mail : corporate@usha.com Website : www.usha.com

Regd. Office : Surya Kiran Building, 19 Kasturba Gandhi Marg, New Delhi (India) Tel : +91 11 23318114 Fax : +91 11 23318118

Fans • Sewing Machines • Home Appliances • Engines & Pumpsets • Electrical Motors & Pumps • Water Coolers & Dispensers
• Inverters • Cook Tops, Hobs & Hoods • Auto Components

USHA

® Registered Trademark and Copyright of USHA INTERNATIONAL LTD.



® Registered Trademark of USHA INTERNATIONAL LTD.

ISO 9001:2015
Certified Company